



INTERLOCKED SOCKET WATERTIGHT 125A IP67 - UBV3125-6



125A 4Pole - 3Pole + E

Operating Voltage - 230 - 400V
 Frequency - 50/60Hz
 Clock Position, colour code - 6 ■

Watertight socket for wall mounting with cable connection possible from top and bottom.
 Mechanical Interlock. Top Entry.
 Connectable Cable Size: 50 mm²
 Degree of protection IP67.

PRODUCT MEASUREMENTS

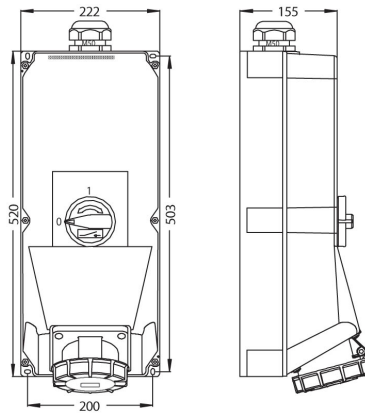

In	Poles	H x W x D
125A	4	520 x 222 x 155

Our IEC/CEE connectors are now tested and certified under the international standard IEC 60 309, which has been developed in the IEC standardisation organisation (International Electrotechnical Commission). This worldwide standard is systematically applied to all GARO products. The use of this standard eliminates the possibility of incorrect connections, regardless of the circumstances.

The standardised products are colour-coded according to a clock face, where the clock positions (1 to 12) correspond to the earth socket position in the socket, viewed from the front, with the locating groove always at the 6 o'clock position. Each position corresponds to a voltage and frequency value of each 2, 3 and 4 pole socket with rated currents of 16A, 32A, 63A and 125A and voltages of >50V to 690V.

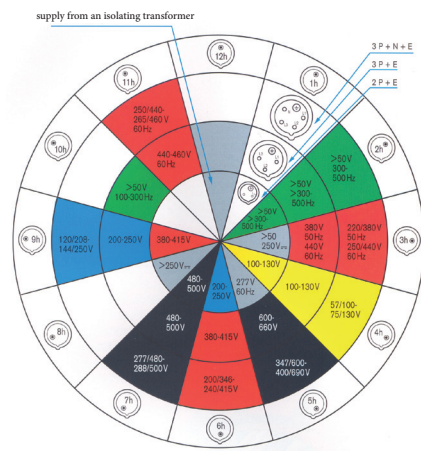

GARO plugs and sockets are tested and certified and comply with the following international and national standards, among others:

IEC 60 309-2, IEC 60 309-1, SS EN 60309-1, SS EN 60309-2, CEE17, SEMKO 117, VDE 0623, BS 4343, EN 50 250



Dokument/document		Utgåva datum/edition date
Försäkran om överensstämmelse/ Declaration of conformity		2018-08-22
Avdelning/department		
Produkt/Product		
Ansvarig/prepared	Version	Sida/page
Robert Nydén	5	1 av/of 1

Manufacturer/Tillverkare: GARO AB
Box 203
S-335 25 GNOSJÖ
Sweden

Telephone: +46 (0)370 33 28 00
Internet: www.garo.se

Agent established within EC/Ombud etablerad inom EG

Agent of equipment/Materielslag: Industrial Socket Outlet / Plugtop / Coupler / Adapter - IP44 / IP67

Trade Mark/Varumärke: GARO

Type Designation/Typbeteckning: UI + UIV + UISV + UIS + UIL + S + SV + P3S + PV3S ..., 216-..., 316-..., 416-..., 232-..., 332-..., 432-..., 263-..., 363-..., 463-..., 2125 ..., 3125 ..., 4125-... and/och

**We hereby declare that our product fulfils the requirements of following EC directives/
Vi intygar härmed att vår produkt uppfyller krav enligt följande EU direktiv:**

- The Low Voltage Directive (LVD) 2014/35/EU / Lågspänningsdirektivet (LVD) 2014/35/EU.**
- Electromagnetic compatibility (EMC) 2014/30/EU / Elektromagnetisk kompatibilitet (EMC) 2014/30/EU.**
- Radio Equipment Directive 2014/53/EU (RED) 2014/30/EU / Radiodirektivet (RED) 2014/53/EU.**
- RoHS Directive (RoHS) 2011/65/EU / RoHS direktivet (RoHS) 2011/65/EU.**
- No electromagnetic compatibility (EMC 2014/30/EU) immunity or emission tests are required on the assembly /** Produkten innehåller inte elektroniska apparater som påverkas enligt förbehållen enligt direktivet (EMC) 2014/30/EU.

The following harmonised standards (latest edition) or technical specifications which comply with good engineering practice in safety matters in force within the EC have been used in the design:/

Följande harmoniserade standarder (senaste utgåva) eller tekniska specifikationer som uppfyller god säkerhetsteknik praxis inom EG har använts i konstruktionen: **EN 60309-1 and / och EN 60309-2**

- The equipment confirms completely with the above stated harmonised standards or technical specifications./**

Materielen överensstämmer helt med ovan angivna harmoniserade standarder eller tekniska specifikationer.

Or/Eller

- The equipment confirms only partially with the above stated harmonised standards or technical specifications but complies with good practice in safety matters in force within the EC./**

Materielen överensstämmer endast delvis med ovan angivna harmoniserade standarder eller tekniska specifikationer, men uppfyller god säkerhetsteknik praxis inom EG.

We have product surveillance according to CENELEC's harmonised requirements, documents CCA-201.

GARO AB
Company/Företag

2018-08-22
Date/Datum

Sign/Underskrift

Product Manager/Produktchef
Position/Befattning

Robert Nydén
Sign in printed letters/Namnförtydligande